

Varenummer: 03446035
Beskrivelse: Fluro Heavy Duty Ledleje GE 35 GW-2RS
Hul Ø35
Note: 35

Mål

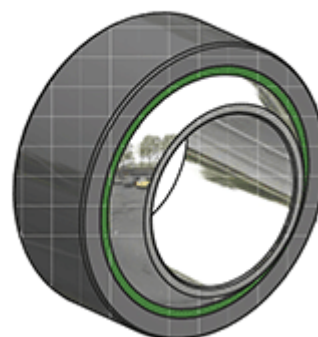
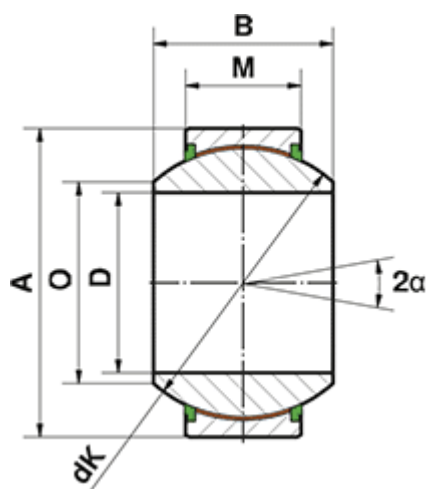

= -	Dynamisk belastning C (kN) = 277
= -	M = 22
= -	O = 39.7
A = 62	Statisk belastning C0 (kN) = 462
a (grader) = 16	Vægt (g) = 380
B = 35	
D = 35	
dK = 53	